

## BLADE REPLACEMENT INSTRUCTIONS

**⚠ WARNING: IF REPLACEMENT IS NOT DONE PROPERLY AND TAIL SPRING RETRACTS INTO T1 BODY, THE TOOL WILL NEED TO BE SHIPPED BACK TO REEKON FOR ADDITIONAL REPAIRS.**

FOR ADDITIONAL HELP REPLACING YOUR T1 BLADE SCAN THE QR CODE OR VISIT OUR WEBSITE AT [REEKON.XYZ/T1B](https://reekon.xyz/t1b)

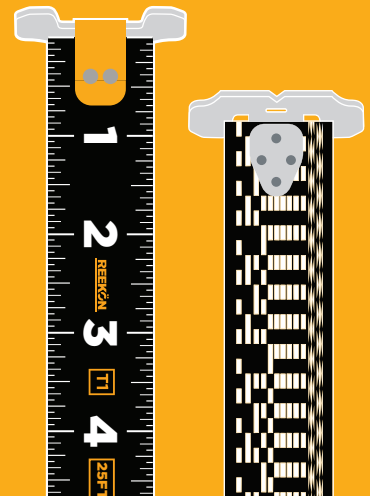

### TOOLS NEEDED



Safety glasses



T1 Replacement Blade



#0 Phillips Head Screwdriver

### PART NAME GUIDE

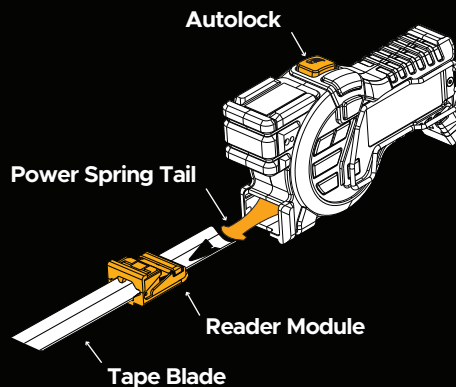

### VIDEO TUTORIAL



Scan the code and visit our website at [reekon.xyz/t1b](https://reekon.xyz/t1b) to see animations and videos of the Blade Replacement process.

## 1. REMOVING THE READER MODULE

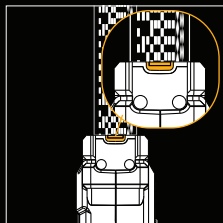

A. Flip your T1 upside down and remove the two screws at the front of your T1 with a #0 Phillips head screwdriver. Next, locate the small tab placed in front of the two screws.

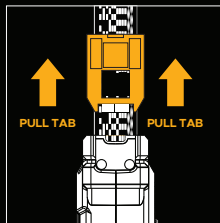

B. Pull on the tab to slide the loose Reader Module out of the T1 shell and flip the T1 right side up.

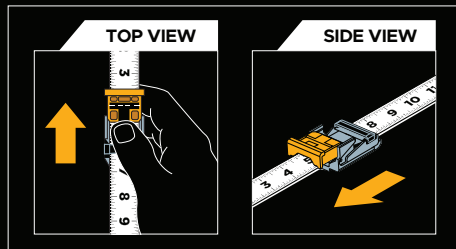

C. Separate the top piece from the bottom piece of the Reader Module by holding the bottom firmly in place and sliding the top piece forward and away from the device with your thumb.

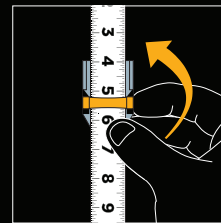

D. Remove the wiper by pulling up on either the left or right side with your finger and thumb.

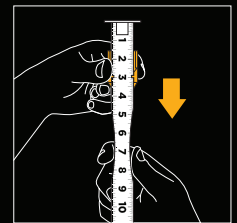

F. Pinch the Tape Blade just below the Reader Module. Then, slide the Reader Module backward to remove it from the Tape Blade.

## 2. SECURING THE POWER SPRING TAIL

**▲ WARNING: STEP 2 IS THE MOST IMPORTANT STEP AND CAN CAUSE DAMAGE TO THE T1 IF NOT DONE PROPERLY.**

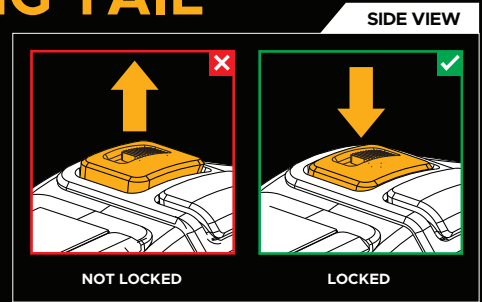
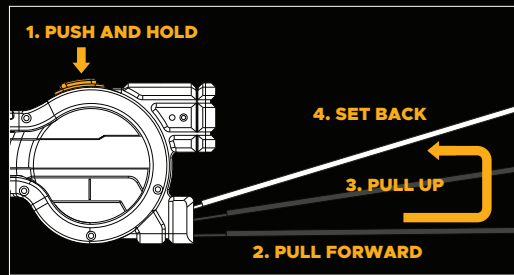

A. Extend the Tape Blade to the end until it turns yellow. You are nearing the end of the Tape Blade. Slowly keep extending until you see the Power Spring Tail that is hooked around the end of the Tape Blade.

B. Press and hold the Autolock button while pulling the Tape Blade FORWARD, UP, then BACK to hook the Power Spring Tail in place, then release the Autolock button. This will hold the Power Spring Tail in place while you exchange your Tape Blade.

**NOTE:** If you release the Autolock button and the tape starts to retract back into the T1 it means you have NOT completed this step correctly. The Autolock button should stay in the locked position after you release it, holding the blade in place while you continue the replacement process.

## 3. REPLACING THE OLD BLADE

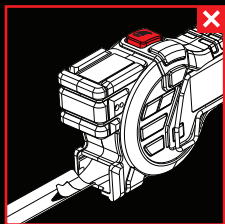

**▲ WARNING: DO NOT press the Autolock button down while the Tape Blade is removed from the T1. This will release the Power Spring Tail, damage your T1, and will require additional services to repair.**

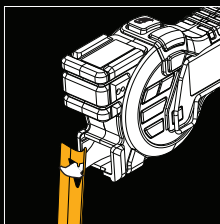

A. Making sure not to pull on the Power Spring Tail, bend the Tape Blade down from its standard position.

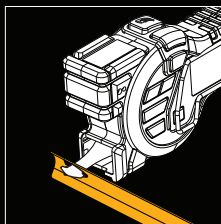

B. Twist the Tape Blade (left or right) 90 degrees.

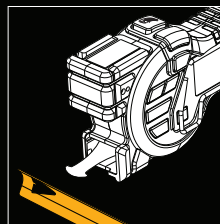

C. Remove the Tape Blade from the Power Spring Tail and hook a new Tape Blade to the Power Tail Spring in reverse order.

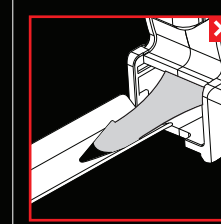

TAIL INSTALLED OVER

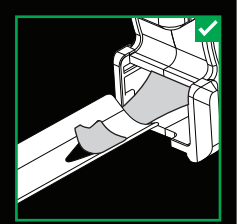

TAIL INSTALLED UNDER

D. When hooking a new Tape Blade on, make sure to have the Power Spring Tail attach from underneath the new Tape Blade, and ensuring that both sides of the Power Spring Tail are wrapped around the top of the Tape Blade.

## 4. REASSEMBLE THE DEVICE

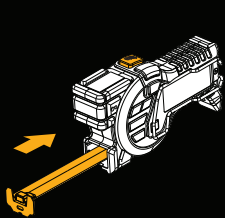

A. Press the Autolock button while pulling on the Tape Blade to unhook the tail. Then reel the Tape Blade back into the T1 shell.

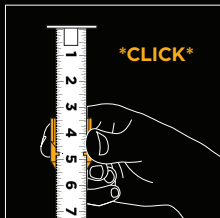

B. Reattach the Lower Reader Module by clipping it to the Tape Blade with the prongs side closest to the T1.

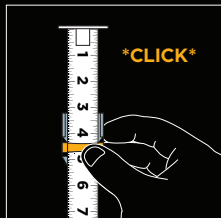

C. Reattach the Wiper Blade to the Lower Reader Module.

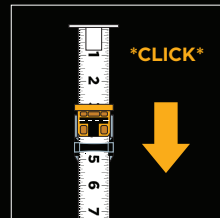

D. Clip the Upper Reader Module to the Lower Reader Module by inserting from front to back.

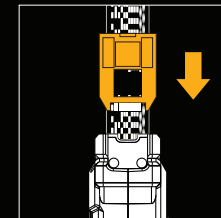

E. Slide the fully assembled Reader Module into the T1 Shell.

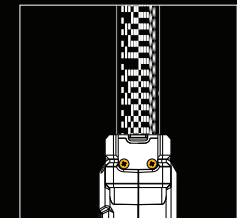

F. Reinstall both screws located at the bottom of your T1.